

# SR-2E-16 CLASSIC PRO BUBBLER, STAINLESS STEEL, GREY

SR2E16GRAY



## RefCC001C (SR2E16GRAY)

Cold beverage dispenser - Classic Pro Bubbler 2x2.4 gallon, with new easy-off release bowl and high efficiency cooling system

### General Features

CLASSIC PRO BUBBLER SR-2E is a cold drink premix dispenser, compact size, with 2x2.4 gallon (9 L) capacity tanks.

The machine cools and dispenses ready-made drinks such as fresh juices, teas, cold brew coffee, cocktails, flavored water etc.

The unique evaporator and the high efficiency system cool faster and more efficiently for a quick start-up.

The superior engineering ensures a perfect temperature from the first to the last drop of dispensed product.

Two-piece dripless pouring valves are easy to use and clean. Suitable for cups up to 9 inch height (22,9 cm).

New easy-off release bowl system, that makes dismantling easier and reduces cleaning time.

Drinks mix with a magnetic submerged impeller. Agitators are provided with each unit. Panels are in stainless steel.

#### OPTIONALS AVAILABLE:

- VALVE CAP: improves sealing of valve when using pulpy product
- FOUNTAIN SPRAY KIT: ideal to create a spectacular effect
- EXCLUSIVE AUTOFILL LID: retrofittable postmix Autofill Lid System increases consistency and exclude SR2E22290NEMA manual filling operations.

CRATHCO

# SR-2E-16 CLASSIC PRO BUBBLER, STAINLESS STEEL, GREY

## Specifications

- Easy-off bowl release system for faster and easier assembly and disassembly.
- User friendly design enables machine to dispense product till the very last drop.
- Suitable for cups up to 8 inch height (20 cm)
- Appealing cold drink dispenser equipped with 2 bowls, 2.4 gallons capacity each
- Agitation function, with low foam impeller cover special for fresh juices, coffees, vitamin waters or tea.

## Construction

- Refrigerant type: R134a.
- Pre-mix dispenser with stainless steel base and clear plastic bowls.
- The air intakes from the bottom and exhaust to back.
- Magnetic Submerged impeller

# SR-2E-16 CLASSIC PRO BUBBLER, STAINLESS STEEL, GREY

## Electric

Supply voltage:	120 V / 1N ph / 60 Hz
Electrical power max.:	0.4 kW
Current consumption:	3.6 Amps
Plug type:	NEMA 5-15

## Key Information:

Number of bowls:	2
Bowl's Capacity	9 gal
Control board:	Mechanical
Dimensions, Width:	10 5/8"
Dimensions, Depth:	16 15/16"
Dimensions, Height:	25 9/16"
Net weight:	53 lb

## Refrigeration Data

Refrigerant gas:	R134a
------------------	-------

## Certifications



The company reserves the right to make modifications to the products without prior notice. All information correct at time of printing.

2025.04.22

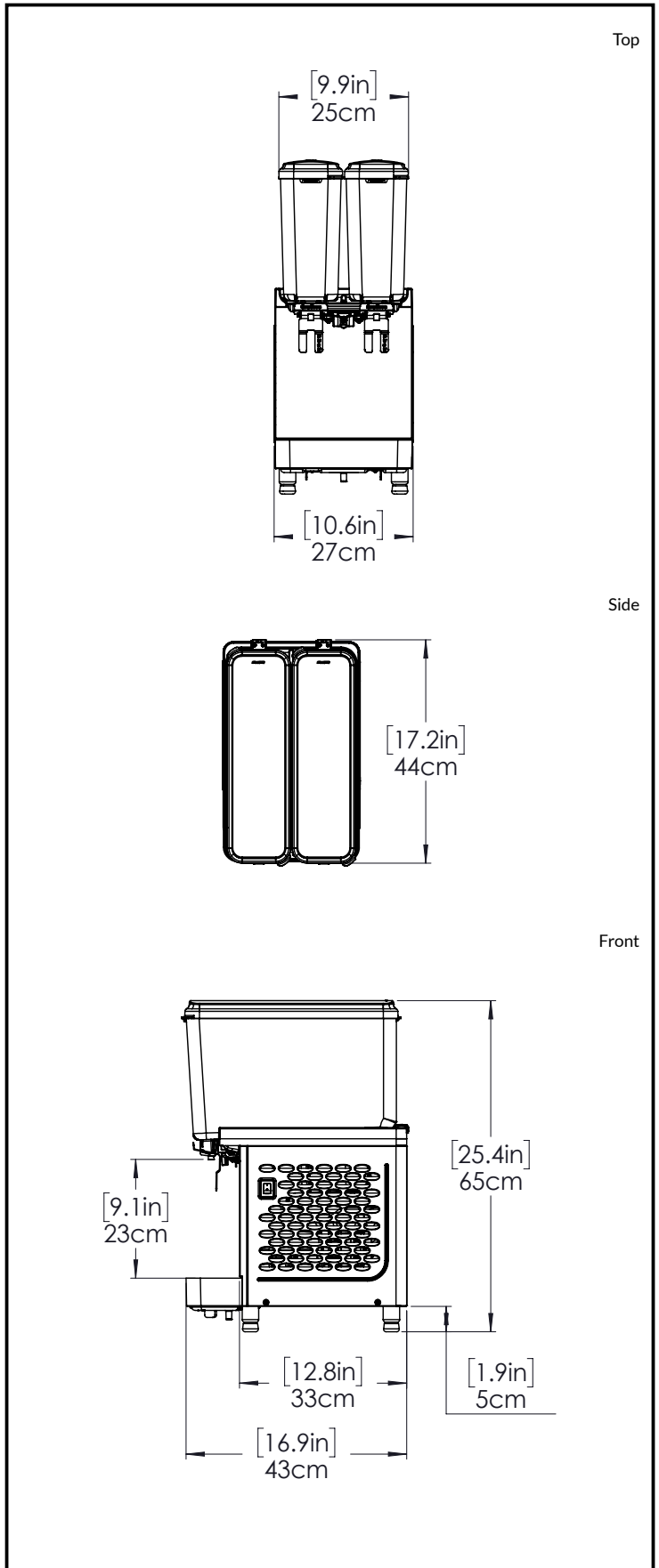

**CRATHCO**

www.crathco.drink-systems.com  
infocrathco@electroluxprofessional.com